

ZERTIFIKAT

Zertifizierte Passivhaus-Komponente

Komponenten-ID 1133ws03 gültig bis 31. Dezember 2019

Passivhaus Institut
Dr. Wolfgang Feist
64283 Darmstadt
Deutschland

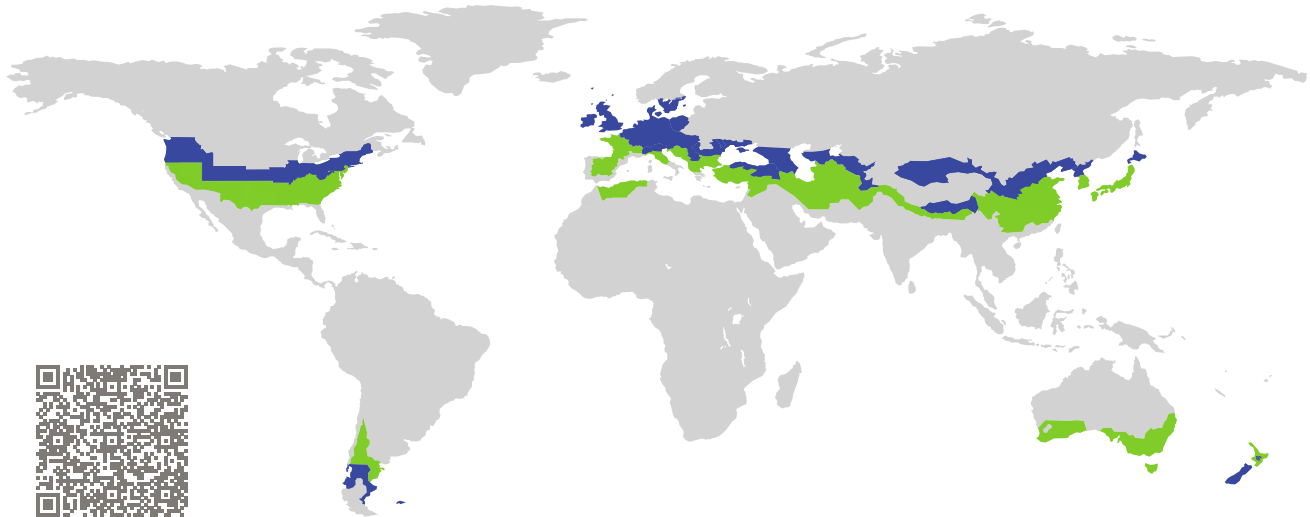

Kategorie: **Fenster System**
Hersteller: **pro Passivhausfenster GmbH,
Oberaudorf,
Deutschland**
Produktname: **smartwin**

**Folgende Kriterien für die kühl-gemäßigte Klimazone
wurden geprüft**

Behaglichkeit $U_W = 0,76 \leq 0,80 \text{ W}/(\text{m}^2 \text{ K})$
 $U_{W,\text{eingebaut}} \leq 0,85 \text{ W}/(\text{m}^2 \text{ K})$
mit $U_g = 0,70 \text{ W}/(\text{m}^2 \text{ K})$

Hygiene $f_{Rsi=0,25} \geq 0,70$
Luftdichtheit $Q_{100} = 0,11 \leq 0,25 \text{ m}^3/(\text{h m})$

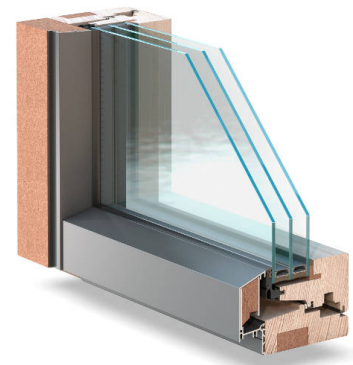

kühl-gemäßigtes Klima



**ZERTIFIZIERTE
KOMPONENTE**

Passivhaus Institut

Passivhaus-
Effizienzklasse

phE

phD

phC

phB

phA

www.passiv.de

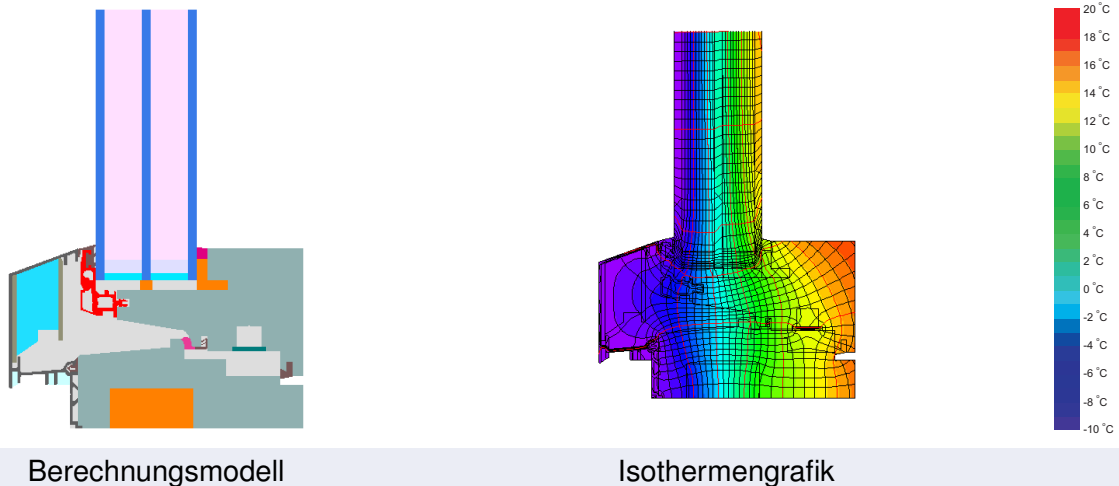

Beschreibung

Fichte/Tanne-Aluminium Rahmen mit Holzfaserdämmung (0,040W/(mK)), in der Regenschiene PU-Schaum (0,027 W/(mK)). Glasstärke: 48 mm (4/18/4/18/4), Glaseinstand: 15 mm, Abstandhalter: SWISSPACER Ultimate mit PU Sekundärdichtung. Die längenbezogene Luftdichtheit, $q_{100} = 0,11 \text{ m}^3/(\text{hm})$ bezieht sich auf eine zweiflüglige Stulpfenstertüre, 2 * 2,6 m.

Erläuterung















Die Fenster-U-Werte wurden für die Prüffenstergröße von 2,46 m × 1,48 m bei $U_g = 0,70 \text{ W}/(\text{m}^2 \text{ K})$ berechnet. Werden höherwertige Verglasungen eingesetzt, verbessern sich die Fenster-U-Werte wie folgt:

Verglasung	$U_g =$	0,70	0,64	0,58	0,52	W/(m ² K)
		↓	↓	↓	↓	
Fenster	$U_W =$	0,76	0,72	0,67	0,62	W/(m ² K)

Transparente Bauteile werden abhängig von den Wärmeverlusten durch den opaken Teil in Effizienzklassen eingestuft. In diese Wärmeverluste gehen die Rahmen-U-Werte, die Rahmenbreiten, Glasrand und die Glasrandlängen ein. Ein ausführlicher Bericht über die im Rahmen der Zertifizierung durchgeführten Berechnungen ist beim Hersteller erhältlich.

Das Passivhaus Institut hat weltweite Komponentenanforderungen für sieben Klimazonen definiert. Grundsätzlich können Komponenten, die für Klimazonen mit höheren Anforderungen zertifiziert sind, auch in Klimazonen mit geringeren Anforderung eingesetzt werden. Es kann wirtschaftlich sinnvoll sein, in einer Klimazone eine thermisch höherwertige Komponente, die für eine Klimazone mit strengeren Anforderungen zertifiziert wurde, einzusetzen.

Weitere Informationen zur Zertifizierung sind unter www.passiv.de und www.passipedia.de verfügbar.

Rahmen-Kennwerte			Rahmenbreite	Rahmen- U -Wert	Glasrand- Ψ -Wert	Temperaturfaktor
			b_f mm	U_f W/(m ² K)	Ψ_g W/(m K)	$f_{Rsi=0,25}$ [-]
Oben	(to)		86	0,68	0,020	0,74
Seite	(s)		86	0,68	0,020	0,74
Unten	(bo)		86	0,89	0,020	0,72
Oben fest	(tof)		86	0,52	0,021	0,76
Seite fest	(sf)		86	0,52	0,021	0,76
Unten fest	(bof)		86	0,69	0,020	0,74
Schwelle	(th)		76	1,00	0,021	0,71
Tür seitlich	(sh)		161	0,68	0,020	0,73
Stulp	(fm)		110	0,79	0,020	0,74
Pfosten fest	(m)		110	0,65	0,021	0,74
Pfosten 1 Flügel	(m1)		110	0,78	0,021	0,73
Pfosten 2 Flügel	(m2)		142	0,76	0,020	0,74
Ecke	(ec)		160	0,31	0,021	0,72
Riegel fest	(tf)		110	0,79	0,020	0,72
Riegel 1 Flügel	(t1)		110	0,96	0,020	0,71
Riegel 2 Flügel	(t2)		142	0,92	0,020	0,72
Abstandhalter: SWISSPACER Ultimate			Sekundär Dichtung: Polyurethan			



Oben

$b_f = 86,00 \text{ mm}$

$U_f = 0,68 \text{ W/(m}^2 \text{ K)}$

$\Psi_g = 0,020 \text{ W/(m K)}$

$f_{Rsi} = 0,74$

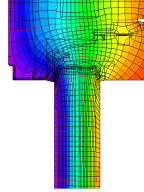

Seite

$$b_f = 86,00 \text{ mm}$$

$$U_f = 0,68 \text{ W}/(\text{m}^2 \text{ K})$$

$$\Psi_g = 0,020 \text{ W}/(\text{m K})$$

$$f_{Rsi} = 0,74$$

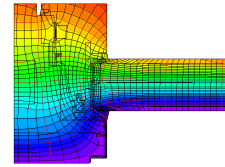
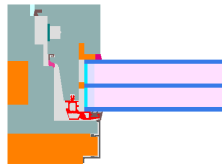

Unten

$$b_f = 86,00 \text{ mm}$$

$$U_f = 0,89 \text{ W}/(\text{m}^2 \text{ K})$$

$$\Psi_g = 0,020 \text{ W}/(\text{m K})$$

$$f_{Rsi} = 0,72$$

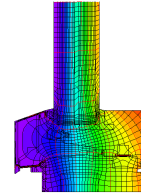
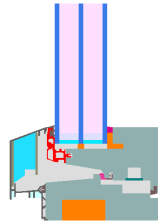

Oben

fest

$$b_f = 86,00 \text{ mm}$$

$$U_f = 0,52 \text{ W}/(\text{m}^2 \text{ K})$$

$$\Psi_g = 0,021 \text{ W}/(\text{m K})$$

$$f_{Rsi} = 0,76$$

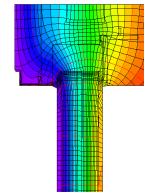
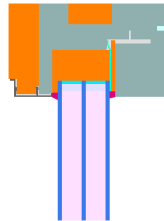

Seite

fest

$$b_f = 86,00 \text{ mm}$$

$$U_f = 0,52 \text{ W}/(\text{m}^2 \text{ K})$$

$$\Psi_g = 0,021 \text{ W}/(\text{m K})$$

$$f_{Rsi} = 0,76$$

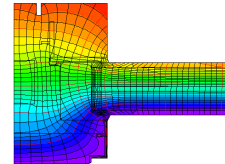
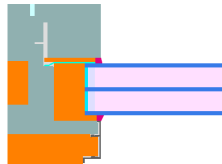

Unten

fest

$$b_f = 86,00 \text{ mm}$$

$$U_f = 0,69 \text{ W}/(\text{m}^2 \text{ K})$$

$$\Psi_g = 0,020 \text{ W}/(\text{m K})$$

$$f_{Rsi} = 0,74$$

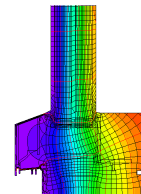
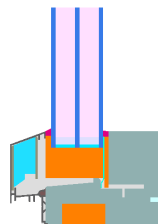



Schwelle

$$b_f = 76,00 \text{ mm}$$

$$U_f = 1,00 \text{ W}/(\text{m}^2 \text{ K})$$

$$\Psi_g = 0,021 \text{ W}/(\text{m K})$$

$$f_{Rsi} = 0,71$$

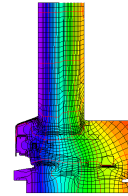
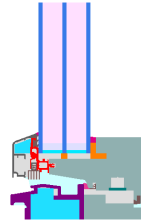

Tür seitlich

$$b_f = 161,00 \text{ mm}$$

$$U_f = 0,68 \text{ W}/(\text{m}^2 \text{ K})$$

$$\Psi_g = 0,020 \text{ W}/(\text{m K})$$

$$f_{Rsi} = 0,73$$

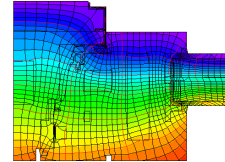

Stulp

$$b_f = 110,00 \text{ mm}$$

$$U_f = 0,79 \text{ W}/(\text{m}^2 \text{ K})$$

$$\Psi_g = 0,020 \text{ W}/(\text{m K})$$

$$f_{Rsi} = 0,74$$

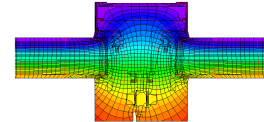
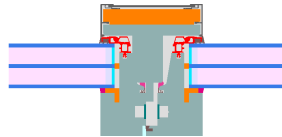

Pfosten fest

$$b_f = 110,00 \text{ mm}$$

$$U_f = 0,65 \text{ W}/(\text{m}^2 \text{ K})$$

$$\Psi_g = 0,021 \text{ W}/(\text{m K})$$

$$f_{Rsi} = 0,74$$

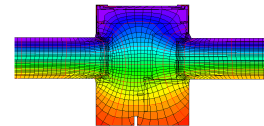
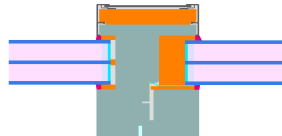

Pfosten 1 Flügel

$$b_f = 110,00 \text{ mm}$$

$$U_f = 0,78 \text{ W}/(\text{m}^2 \text{ K})$$

$$\Psi_g = 0,021 \text{ W}/(\text{m K})$$

$$f_{Rsi} = 0,73$$

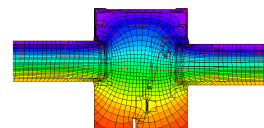
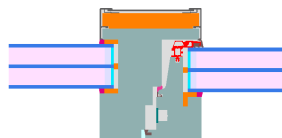



Pfosten

2 Flügel

$$b_f = 142,00 \text{ mm}$$

$$U_f = 0,76 \text{ W}/(\text{m}^2 \text{ K})$$

$$\Psi_g = 0,020 \text{ W}/(\text{m K})$$

$$f_{Rsi} = 0,74$$

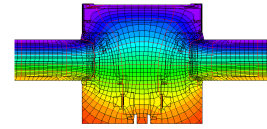
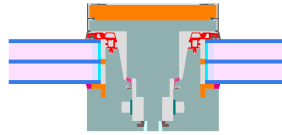

Ecke

$$b_f = 160,00 \text{ mm}$$

$$U_f = 0,31 \text{ W}/(\text{m}^2 \text{ K})$$

$$\Psi_g = 0,021 \text{ W}/(\text{m K})$$

$$f_{Rsi} = 0,72$$

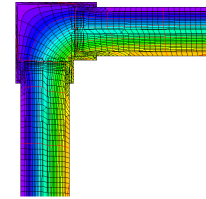
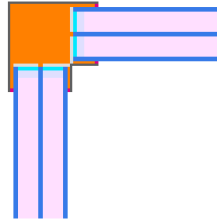

Riegel

fest

$$b_f = 110,00 \text{ mm}$$

$$U_f = 0,79 \text{ W}/(\text{m}^2 \text{ K})$$

$$\Psi_g = 0,020 \text{ W}/(\text{m K})$$

$$f_{Rsi} = 0,72$$

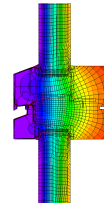
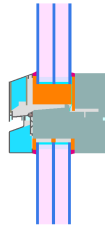

Riegel

1 Flügel

$$b_f = 110,00 \text{ mm}$$

$$U_f = 0,96 \text{ W}/(\text{m}^2 \text{ K})$$

$$\Psi_g = 0,020 \text{ W}/(\text{m K})$$

$$f_{Rsi} = 0,71$$

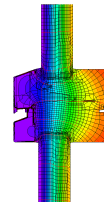
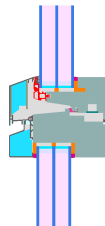

Riegel

2 Flügel

$$b_f = 142,00 \text{ mm}$$

$$U_f = 0,92 \text{ W}/(\text{m}^2 \text{ K})$$

$$\Psi_g = 0,020 \text{ W}/(\text{m K})$$

$$f_{Rsi} = 0,71$$

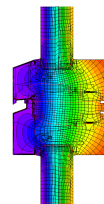
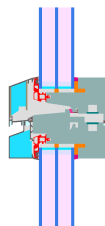

Geprüfte Einbausituationen

Wärmedämmverbundsystem (WDVS) (fest verglast)

$U_{Wand} = 0,13 \text{ W}/(\text{m}^2 \text{ K})$

Ψ_{einbau}	W/(m K)
Oben	-0,001
Links	-0,001
Rechts	-0,001
Unten	0,013

$U_{W,\text{eingebaut}} = 0,77 \text{ W}/(\text{m}^2 \text{ K})$

Betonschalungsstein (fest verglast)

$U_{Wand} = 0,15 \text{ W}/(\text{m}^2 \text{ K})$

Ψ_{einbau}	W/(m K)
Oben	0,000
Links	0,000
Rechts	0,000
Unten	0,015

$U_{W,\text{eingebaut}} = 0,78 \text{ W}/(\text{m}^2 \text{ K})$

Betonschalungsstein (öffenbar)

$U_{Wand} = 0,15 \text{ W}/(\text{m}^2 \text{ K})$

Ψ_{einbau}	W/(m K)
Oben	0,001
Links	0,001
Rechts	0,001
Unten	0,016

$U_{W,\text{eingebaut}} = 0,78 \text{ W}/(\text{m}^2 \text{ K})$

Holzleichtbau (fest verglast)

$U_{Wand} = 0,13 \text{ W}/(\text{m}^2 \text{ K})$

Ψ_{einbau}	W/(m K)
Oben	0,011
Links	0,011
Rechts	0,011
Unten	0,018

$U_{W,\text{eingebaut}} = 0,79 \text{ W}/(\text{m}^2 \text{ K})$

Holzleichtbau (öffenbar)

$U_{Wand} = 0,13 \text{ W}/(\text{m}^2 \text{ K})$

Ψ_{einbau}	W/(m K)
Oben	0,011
Links	0,011
Rechts	0,011
Unten	0,018

$U_{W,\text{eingebaut}} = 0,79 \text{ W}/(\text{m}^2 \text{ K})$

Wärmedämmverbundsystem (WDVS) (öffenbar)

$U_{Wand} = 0,13 \text{ W}/(\text{m}^2 \text{ K})$

Ψ_{einbau}	W/(m K)
Oben	0,005
Links	0,005
Rechts	0,005
Unten	0,034

$U_{W,\text{eingebaut}} = 0,80 \text{ W}/(\text{m}^2 \text{ K})$

Wärmedämmverbundsystem (WDVS)
seite (öffnenbar)

$$U_1 = 0,13 \text{ [W/(m}^2 \text{ K)]}$$

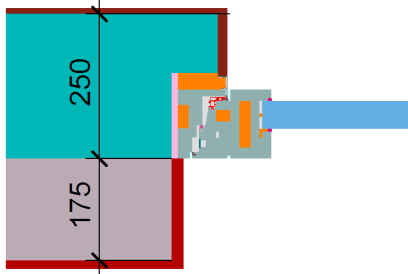

$$\Psi_{\text{einbau}} = 0,00 \text{ W/(m K)}$$

Wärmedämmverbundsystem (WDVS)
Schwelle (öffnenbar)

$$U_1 = 0,14 \text{ [W/(m}^2 \text{ K)]}$$

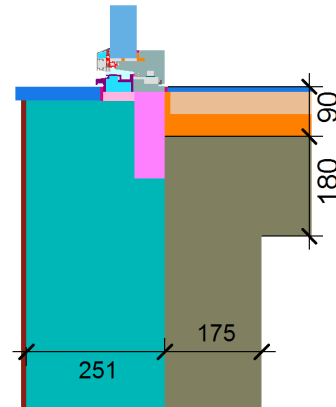

$$\Psi_{\text{einbau}} = 0,02 \text{ W/(m K)}$$

